

2m Performance Broadloom

Interface®

Important notices

These Installation Instructions cover the most common installation circumstances. If you run across a situation that isn't addressed here, in the U.S. call the Interface Americas Help Desk at (877) 733-7403. In Canada, call (800) 267-2149.

All carpet should be carefully inspected for damage or defects prior to installation. Interface will not be responsible for damage or loss caused by installation of carpet having damage or defects which were identifiable prior to installation.

If you encounter any conditions or defects during installation which could jeopardize the installation or affect the installation procedure, you should STOP the installation immediately and call the Interface Americas Help Desk at (877) 733-7403. In Canada, call (800) 267-2149.

The carpet is warranted in accordance with Interface Flooring Systems' Standard Product Warranty. If you do not have a copy of Interface Flooring Systems' Standard Product Warranty and wish to obtain one, call the Interface Americas Help Desk at (877) 733-7403. In Canada, call (800) 267-2149. **EXCEPT AS EXPRESSLY PROVIDED IN THE STANDARD PRODUCT WARRANTY, INTERFACE MAKES NO REPRESENTATIONS OR WARRANTIES, EXPRESS OR IMPLIED, INCLUDING, WITHOUT LIMITATION, ANY WARRANTY OF MERCHANTABILITY OR FITNESS OF ITS PRODUCTS FOR ANY PARTICULAR PURPOSES, AND HEREBY DISCLAIMS THE SAME.**

Without limiting the foregoing, Interface will not be responsible for staining, soiling, contamination, tears, burns cuts, pulls or other damage, deterioration or loss caused by abuse, misuse, improper installation, improper maintenance or failure to protect carpet during building construction.

Interface shall not be responsible for any damage or loss resulting from failure to strictly follow any part of these Installation Instructions, and such failure shall void any and all portions of the Standard Product Warranty which are affected by such failure.

WARNING: IN THE EVENT THAT ANY ASBESTOS-CONTAINING MATERIALS OR OTHER HAZARDOUS MATERIALS ARE ENCOUNTERED DURING INSTALLATION, YOU SHOULD STOP THE INSTALLATION IMMEDIATELY AND OBTAIN ASSISTANCE FROM A QUALIFIED REMEDIATION CONSULTANT OR CONTRACTOR PRIOR TO PROCEEDING.

Follow CRI installation standards

In addition to the specific floor preparation and installation instructions detailed here, the Carpet and Rug Institute Standard for Installation of Commercial Carpet (CRI 104) must be followed. Please note that many of the following installation requirements may exceed those in the CRI standard.

Pre-installation visit

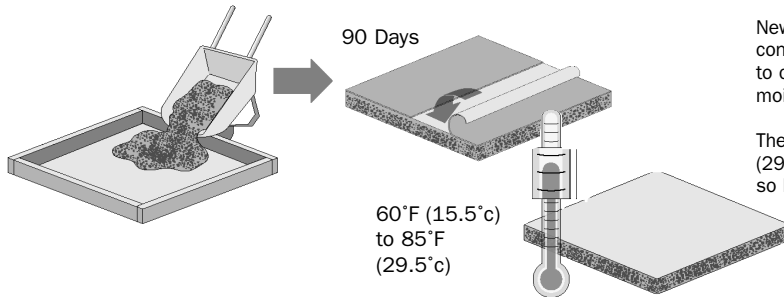

New concrete needs at least 90 days to fully cure. Lightweight concrete and concrete poured above grade in metal pans take a considerably longer time to cure. Installation cannot begin until it is fully cured and in compliance with moisture and alkalinity requirements.

The temperature of your job site must stay within 60°F (15.5°C) and 85°F (29.5°C) 48 - 72 hours prior to, during, and 48 - 72 hours after installation so be sure the heating and air conditioning system is operating.

Carpet must be rolled out and allowed to adjust to the job site temperature for 48 hours prior to installation.

Moisture and alkalinity test

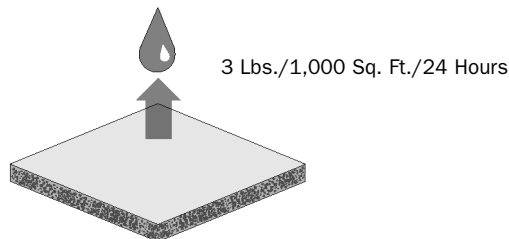

NOTE: Per CRI guidelines, it is recommended that the necessary pre-installation moisture and alkalinity tests be performed by a qualified independent testing consultant. These tests must be conducted to the ASTM guidelines.

Interface will not be responsible for failures, problems, or damage arising from high moisture, high alkalinity, or other subfloor conditions.

Before installing carpet over a new or existing concrete subfloor, you must test the moisture and alkalinity levels of the concrete.

Moisture emissions should be determined by use of an Anhydrous Calcium Chloride test kit. The test must be administered to the specification of the ASTM F 1869 test procedure.

Moisture emissions must not exceed 3 pounds per 1,000 square feet for 24 hours. If the concrete test is higher than 3 pounds, do not proceed with the installation. Call the Interface Americas Help Desk at (877) 733-7403. In Canada, call (800) 267-2149.

Moisture and alkalinity test, continued

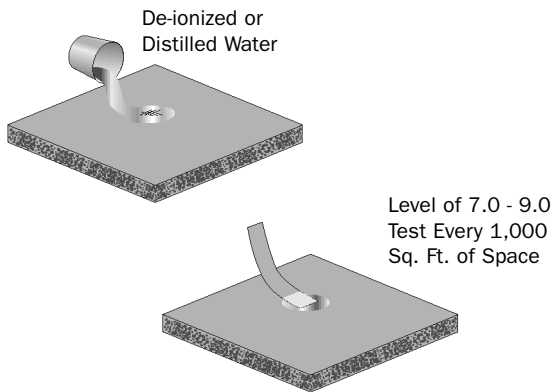
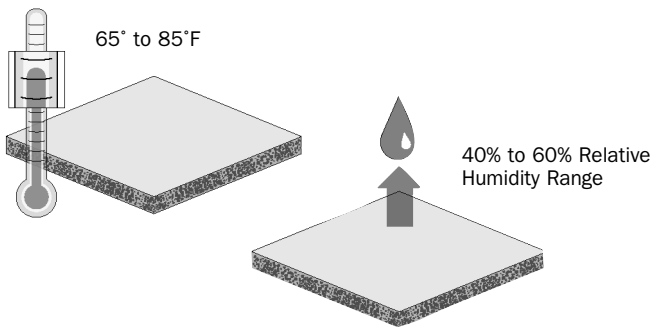

All concrete floors, old and new, should be tested for alkalinity by using an alkalinity test kit. The pH test papers should be capable of measuring a range of 0 -14. The area to be tested must be weather-tight and conditioned, via the building's HVAC system, to a temperature range of 65° - 85° Fahrenheit and a relative humidity range of 40% - 60%. This temperature and humidity range must be maintained for at least 48 hours immediately prior to commencing the test, and at all times during the test. All adhesives, coatings, finishes, dirt, curing compounds, sealant and other substances which may affect the rate of moisture dissipation must be removed from the area to be tested. Non-chemical methods, such as abrasive cleaning or bead blasting may be used on existing slabs to achieve an appropriate state for testing. Any cleaning should take place a minimum of 48 hours before testing.

Once this criteria has been met:

1. Abrade the surface by scratching into the clean slab a minimum of 1/32" but no more than 1/8".
2. Apply a small amount (approximately 1" in diameter) of de-ionized or distilled water.
3. Allow the de-ionized/distilled water to stand for 60 seconds.
4. Dip the 0-14 pH test strip into the puddle and remove immediately.
5. Compare to the test kits associated pH chart to determine the pH.
6. At least one pH test must be performed for every 1,000 square feet of space.

The slab should have an alkalinity level between 7.0 - 9.0 to be suitable for carpet installation. Should the pH level be outside of this range **STOP, and DO NOT proceed with installation.** Call the Interface Americas Help Desk at (877) 733-7403. In Canada, call (800) 267-2149.

NOTE: Test results reflect the condition of the slab at the time of testing.

Product inspection

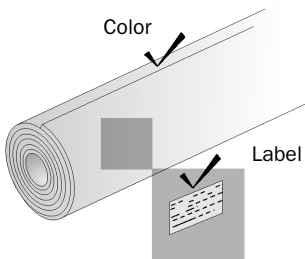

Inspect 2m Performance Broadloom to be sure it meets the order specifications. IF THE WRONG PRODUCT OR COLOR IS INSTALLED, INTERFACE WILL NOT BE RESPONSIBLE FOR CORRECTING THE PROBLEM.

The labels on each roll indicate product style, pattern, color, run number and dye lot. Be sure the style, pattern and color match the specifications for each area of your installation. On larger installations, you may find that some rolls have different run numbers and/or dye lots. To avoid subtle variations in the finished installation, do not mix run numbers or dye lots in the same area.

Check to confirm that you have the right quantity and correct installation method. Be sure you also have enough carpet to establish an "attic stock" for future replacements.

Open all rolls to inspect for damage. If you find any, call the Interface Americas Help Desk at (877) 733-7403. In Canada, call (800) 267-2149.

Lighting

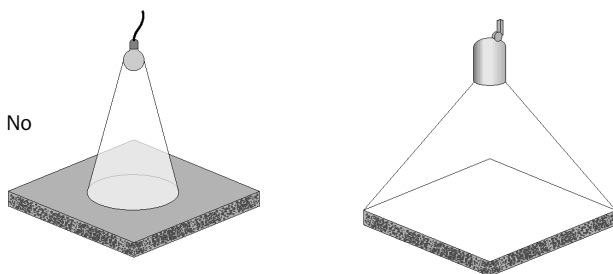

The lighting to be used by the building occupants must be in service for proper inspection of color and joints.

Installation of carpet should be the last item on the construction schedule. Carefully consider the risks if you are asked to install carpet too early. IF CARPET IS INSTALLED BEFORE CONSTRUCTION IS COMPLETE, ANY STAINING, SOILING OR DAMAGE CAUSED BY OTHER TRADES MAY VOID THE PRODUCT WARRANTY.

Tools

Proper installation requires tools on the following checklist.

- | | |
|--|---|
| <input type="checkbox"/> English/metric steel measuring tape | <input type="checkbox"/> Dispenser bottle for seam sealer |
| <input type="checkbox"/> White chalk line | <input type="checkbox"/> Cushionback top cutter |
| <input type="checkbox"/> Carpet knife | <input type="checkbox"/> Wall trimmer |
| <input type="checkbox"/> Carpet knife replacement blades | <input type="checkbox"/> White clothes |
| <input type="checkbox"/> 6' steel straight edge | <input type="checkbox"/> Broom |
| <input type="checkbox"/> 1/16" notched trowel | <input type="checkbox"/> Sander |
| <input type="checkbox"/> Kneekicker | <input type="checkbox"/> Vacuum |
| <input type="checkbox"/> 75 lb. carpet roller | <input type="checkbox"/> Hammer |
| <input type="checkbox"/> Seam tractor | <input type="checkbox"/> Scraper |

Preparing the subfloor

Installing over concrete

Level

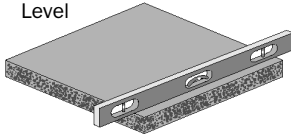

Level the floor to the standards outlined in the American Concrete Institute specifications for Concrete Building (ACI 301) — 11.7.3 troweled finish and 11.9.1 finishing tolerances. Leveling compounds must be Portland-based cement.

Patch Compound

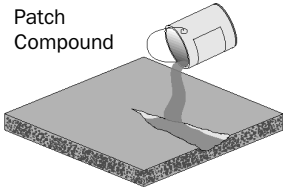

Sand

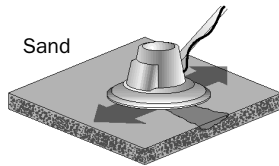

Patch cracks and holes with one of the following approved patching compounds: Lev-L-Astic, Fixall, Armstrong 5-180, Webpatch or Ardex K-15T4. Note that some patching compounds can be mixed with water while some must be mixed with latex. Follow the manufacturer's specification and instructions for use.

After patched areas have dried, sand all patched areas level.

Barrier Coat

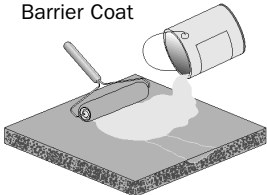

Use an appropriate cleaner to remove any dirt, grease, oil, paint, sealer, adhesive or other materials from floor. Make sure no cleaner residue remains after cleaning.

For enhanced performance, we recommend the use of Re:Source 3300 primer barrier coat. With a roller, apply Re:Source 3300 Primer Barrier Coating over the entire surface.

Installing over wood, plywood or particle board

Repair

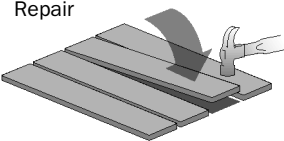

Repair loose or broken boards. Secure with 8-D cement-coated screw nails.

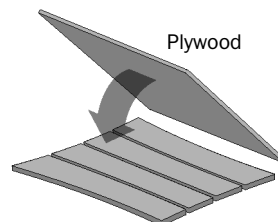

Plywood

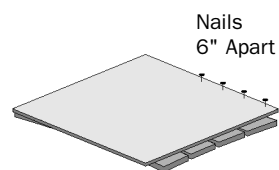

Nails
6" Apart

If the majority of the boards are worn or badly cupped, cover with 5/8 inch (1.6 cm) exterior grade AD plywood secured with 8-D cement-coated screw nails spaced 6 inches (15.2 cm) apart. Sand seams smooth.

Sand

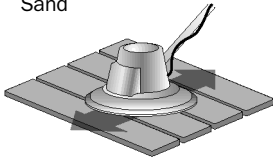

Barrier Coat

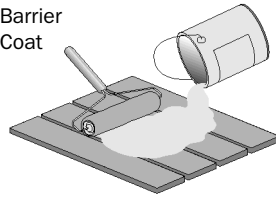

Sand the finish down to bare wood.

Remove dust by sweeping, then wiping with a tack cloth.

With a roller apply Re:Source 3300 Primer Barrier Coating over the entire surface.

Installing over vinyl tile, sheet vinyl or natural materials

Sand

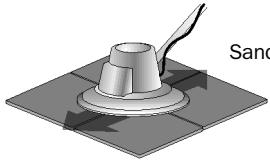

WARNING: EXISTING FLOOR COVERING MAY CONTAIN ASBESTOS OR OTHER HAZARDOUS MATERIALS. IN THE EVENT ASBESTOS CONTAINING MATERIALS OR OTHER HAZARDOUS MATERIALS ARE ENCOUNTERED, YOU SHOULD STOP THE INSTALLATION IMMEDIATELY AND OBTAIN ASSISTANCE FROM A QUALIFIED REMEDIATION CONSULTANT OR CONTRACTOR PRIOR TO PROCEEDING.

Use an appropriate stripper or a sander to remove the wax top coat.

Remove

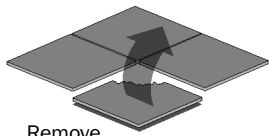

Replace

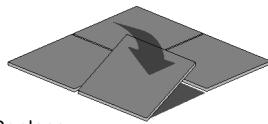

Remove all vinyl tiles with a scraper or replace damaged tiles with substitute tiles of the same thickness. With a roller apply Re:Source 3300 Primer Barrier Coating over the entire surface.

Remove

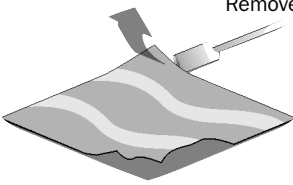

Barrier Coat

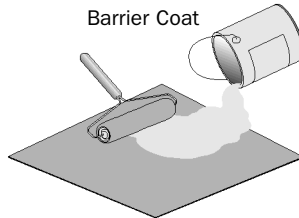

Remove sheet vinyl with a scraper. With a roller apply Re:Source 3300 Primer Barrier Coating over the entire surface.

Remove

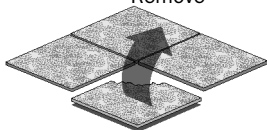

Replace

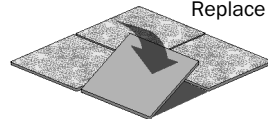

For natural materials such as granolithic, terrazzo, marble, ceramic tile, etc., breakout and remove all material or replace damaged areas with substitute material of the same thickness.

Fill

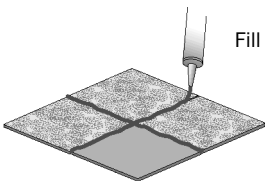

Patch and fill cracks and irregularities, including grout lines, with one of the following approved patching compounds: Lev-L-Astic, Fixall, Armstrong 5-180, Webpatch or Ardex K-15T4. Note that some patching compounds can be mixed with water while some must be mixed with latex. Follow the manufacturer's specification and instructions for use.

Sand

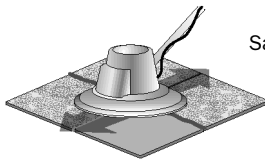

Barrier Coat

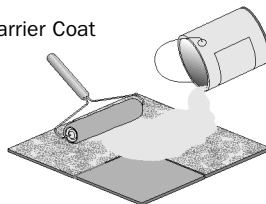

Sand top surface to remove glaze.

Remove dust by sweeping, then wiping with a tack cloth.

Apply Re:Source 3300 Primer Barrier Coating over the entire surface.

Making seams

Install all rolls in roll sequence.

Layout

Snap Chalk
Line

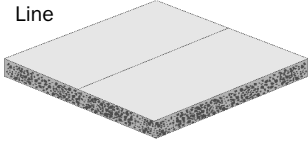

1. Follow industry accepted methods for glue down installation as outlined in most recent edition of CRI installation standard 104.
2. Based on floor plan and seaming diagram, start near the center of the room. Snap a chalk line between opposite walls. This will be the first seam. Ideally, all the carpet should be laid out squared with the dominant wall.
3. Rough cut to fit and trim side seams before any glue is spread.

Arrow direction and seam cutting

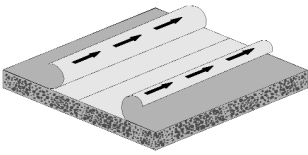

Use Top
Cutter

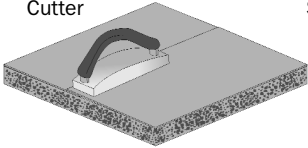

Use Serpentine
Straight Edge

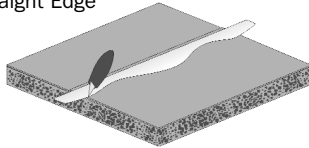

All seams should be trace cut, unless serpentine is specified.

Floor outlets

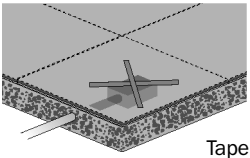

Tape

Floor outlets are usually wired after carpet has been installed. Consequently, you should install carpet directly over floor outlets and mark the location with tape. This way, it will be easy to see where to cut out later.

Applying adhesive

Use only Re:Source 2100 Pressure Sensitive Adhesive on all areas other than stairs. In Canada, use only Re:Source 2100 Pressure Sensitive Adhesive on all areas other than stairs.

On stairs, use only Re:Source 1000 Adhesive for unbacked material for treads. For stair nosing, use manufacturer's recommended installation method.

Adhesive in special situations

No

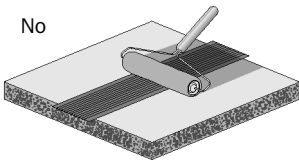

FLATWIRE

Never apply adhesive directly over flatwire. The flatwire may be damaged if the carpet needs to be removed.

UNEVEN AREAS

Any surface that cannot be leveled may require adhesive or double-sided tape to hold carpet in place.

Spread adhesive

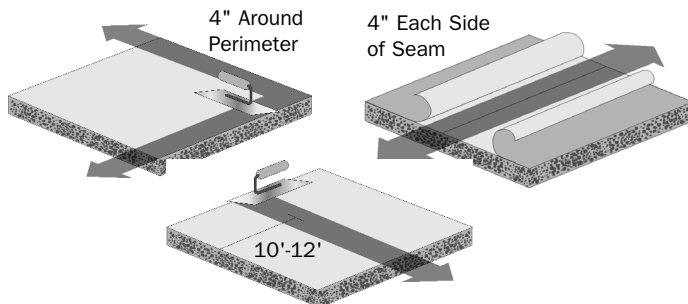

After adhesive begins to flash off, lay one side of seam into adhesive.

1. Spread adhesive with 1/16" v-notched trowel about 4" along the perimeter of area being installed.
2. Then spread 4" of adhesive on either side of all seams. Approximately every 10'-12', also spread 4" of adhesive across the entire width of the carpet. This is for standard traffic areas. In an area that will have heavy rolling carts or dollies, there should be a full spread of adhesive.

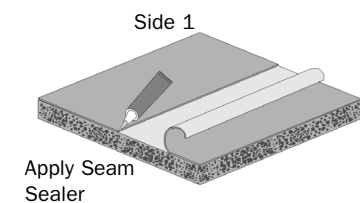

3. After laying one side of seam into adhesive, apply Seam Sealer 4000 to vinyl backing. Apply sealer to very bottom of cut edge only.

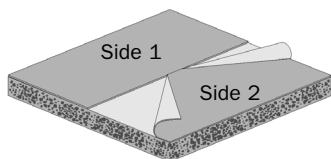

4. Then lay side two into the adhesive and Seam Sealer starting in the middle of the seam and working toward the ends using a knee kicker to bump seam together. Use seam tractor on seam as you move along seam. When seam is complete, clean with Seam Cleaner for Vinyl Back Seam Sealer.

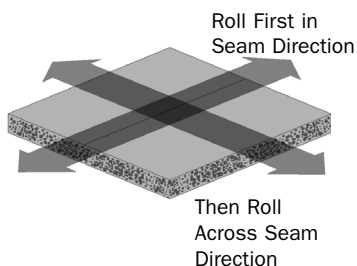

5. Continue this process until floor is complete. When seams are complete, use a 75 lb. carpet roller to roll entire floor starting with the seam (or seams.) Roll first in seam direction and then across seam direction.

There should be no use of the floor for 12 hours. After 12 hours, light foot traffic until 24 hours. After 24 hours, standard use of floor may resume.

Preparing for occupation

Final inspection and vacuum

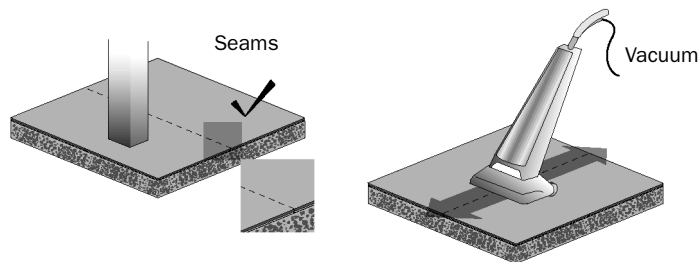

Inspect the entire installation, paying close attention to seams.

Vacuum the floor with a pile lifter. If you don't have a pile lifter, use an upright vacuum cleaner.

Interface®